



Oven-Grill

SOG700/750 & SOV700 Series

SOG52 & SOV52 Series

User Manual

EN

Original User Manual

Contents

1	Introduction.....	2
2	Symbols.....	3
3	Safety.....	3
4	Main components.....	6
5	Before use.....	7
6	Use of the grill (if applicable).....	7
7	Use of the oven.....	9
8	Safe cooking.....	10
9	Temperature control.....	10
10	Maintenance and cleaning.....	11
11	Gas leaks.....	12
12	Putting in storage.....	12
13	Technical specifications.....	12
14	Disposal.....	13
15	Service & questions.....	13

1. Introduction

This is the user manual for your Thetford oven & grill. This manual supports the following models: SOG700 / 750 oven & grill, SOV700 oven, SOG52 oven & grill and SOV52 oven series.

Read the safety instructions and information on use and maintenance of the oven & grill carefully before continuing. This will enable you to use the oven & grill safely and efficiently. Retain this manual for future reference.

This document is version SINS2037/1022-V07 of the user manual. Please visit www.thetford.com for the most recent version.

2. Symbols

Key to symbols:



Warning. Risk of injury and/or damage.



Caution. Hot surface. Risk of injury and/or damage.



Attention. Important information.



Note. Information.

3. Safety



This appliance may be used by children aged 8 years or older and persons with reduced physical, sensory or mental capabilities and/or lack of experience and knowledge only if they are supervised or have been given instructions on the safe use of this appliance and understand the potential hazards.



Keep children younger than 8 years away from the appliance, except under constant supervision.



Do not allow children to play with the appliance.



Do not allow children to clean or maintain this equipment unattended.



Use only parts supplied by the manufacturer.



Do not change or adjust anything on the appliance, unless the change is authorised by the manufacturer or its representative.



Use the appliance for cooking only and not for anything else, for example room heating. This can

lead to carbon monoxide poisoning and overheating. The manufacturer cannot be held liable for damage resulting from improper use or incorrect setting of the controls.



This appliance is not intended to be operated by means of an external timer or separate remote-control system.

The use of this gas cooking appliance results in the production of heat, moisture and products of combustion in the room in which it is installed.



Ensure the room has sufficient ventilation when the appliance is in use. During prolonged use, additional ventilation may be needed by opening a window or increasing the extraction force of the hood.



Never extinguish a cooking fire with water. Turn the burner off and cover the flame with a lid or a fire blanket.



The food shelves and trays in the appliance are hot during and after use. Allow all parts to cool before touching them, as this can cause serious injury. Always use oven gloves when removing the shelves and trays.



Do not store items in the appliance.



Do not put heavy objects on the open appliance door.



The appliance and accessible parts become hot when the grill is in use. Young children should be kept away.

Caution, hot surfaces. Refer to manual for grill operation. Grill door must be open when grill is in use.



In the event that abnormal drift in cooking temperature of the oven is observed, have the thermostat checked by a qualified service engineer.



Care should be taken not to overload the oven, allowing adequate spacing to ensure free circulation of heat.



Do not use steam cleaners or pressure washers to clean the appliance. See Maintenance and cleaning for instructions.



Do not allow oil or fat to build up on the appliance. Clean the appliance after each use.



Before cleaning or maintenance work the appliance must be left to cool and be disconnected from the gas and electrical supplies.



4. Main components

SOG700/750 & SOV700

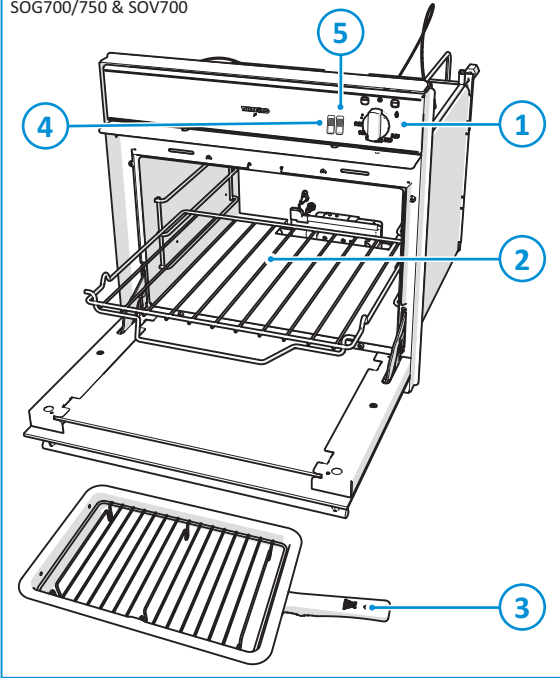

1. Control knob
2. Oven shelf
3. Grill pan
4. Oven light (optional)
5. Spark ignition (optional)

SOG52 & SOV52

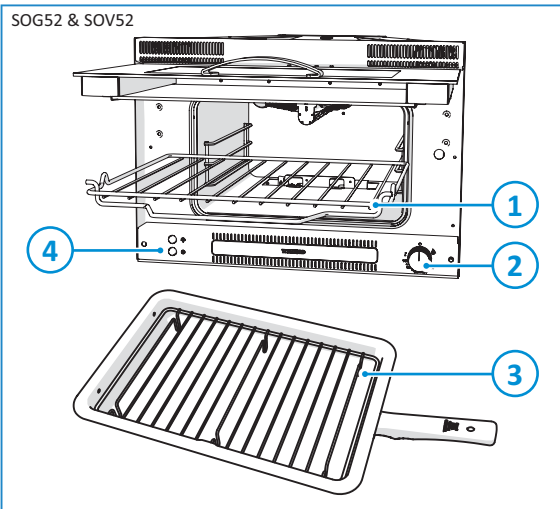

1. Oven shelf
2. Control knob
3. Grill pan
4. Spark ignition

The types of burners may vary depending on the type of appliance. Refer to Technical specifications for further details.

5. Before use

Before using the appliance:

- Ensure that all packaging materials have been removed.
- Clean the appliance with warm water and household detergent and dry carefully with a soft cloth.
- Ensure that the gas supply is connected and turned on.
- Ensure that the appliance is connected to the 12V DC battery for the cooling fans (only for SOG52 & SOV52) and spark ignition.
- Ignite the burner and heat the grill for about 20 minutes to eliminate any residual factory lubricants that might impart unpleasant smells to the food being cooked. Smoke may occur during this procedure. Open any windows and turn on mechanical ventilators to help remove the smoke.
- Ignite the burner and heat the oven for about 30 minutes at 200°C to eliminate any residual factory lubricants that might impart unpleasant smells to cooked food. Smoke may occur during this procedure. Open any windows and turn on mechanical ventilators to help remove the smoke.



Only use LPG (Liquefied Petroleum Gas). The appliance operates on propane or butane. Propane is preferred over butane, because butane provides poor performance at an ambient temperature below 10°C and cannot be used at an ambient temperature below 5°C.

6. Use of the grill (if applicable)

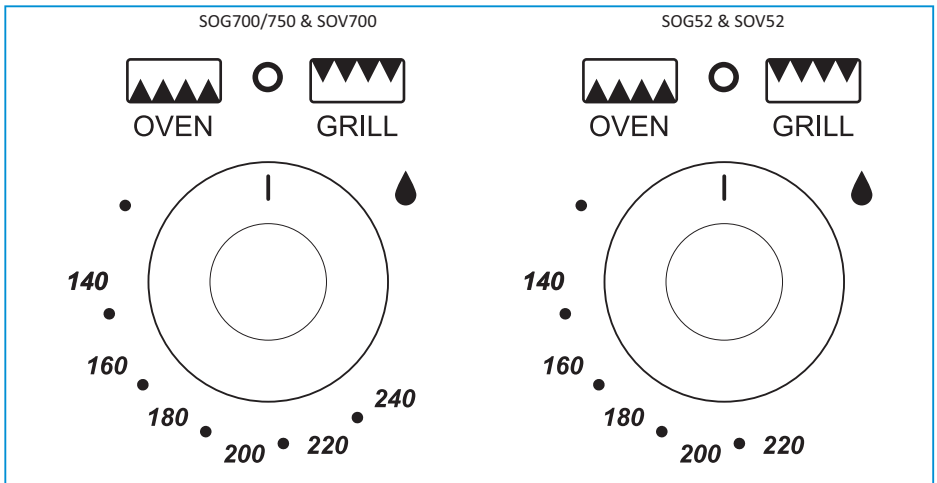

SOV oven-only products do not have the grill function.

For the exact location of the control knob, see Main components.

Turning on:



S0G700 / 750 Only. The heat deflector below the fascia should be extended prior to lighting the grill. Always use oven gloves to adjust the heat deflector position.

- Open the door and push the control knob.
- Continue pressing the control knob and turn it clockwise to the full rate position.
 - For spark ignition models: Push the ignition button.
 - For non-ignition models: Hold a lit match or gas match to the burner.
- Keep the control knob pressed for about 10-15 seconds and then release it.



The grill is only to be used at its nominal heat setting.

- Depending on the food to be cooked, the correct grilling height can be achieved by inverting the pan trivet into either the high or low position.
- The grill pan supplied is multi-functional, for use in grill or oven and the handle design allows removal or insertion whilst the pan is in use. Always remove the handle when the pan is in use.
- Place the shelf in the required position.



The grill door must remain open when lighting and using the grill.



If the burner accidentally extinguishes turn the control knob to the 0 position and wait at least 1 minute before re-igniting the burner.



If the burner has not lit within 15 seconds turn the control knob back to the 0 position and release it. Wait at least 1 minute and repeat the steps above to turn on the appliance.



Although the grill heats up quickly, it is recommended that a few minutes preheat be allowed.



A 12 Volt cooling fan operates automatically above the grill cavity.



It is normal for the flames on this burner to develop yellow tips as the grill heats up.

Turning off:

- Turn the control knob anti-clockwise to the 0 position to turn off the burner.



Always make sure the control knob is in the 0 position when you have finished using the grill.

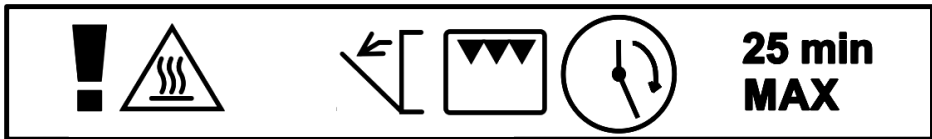

7. Use of the oven

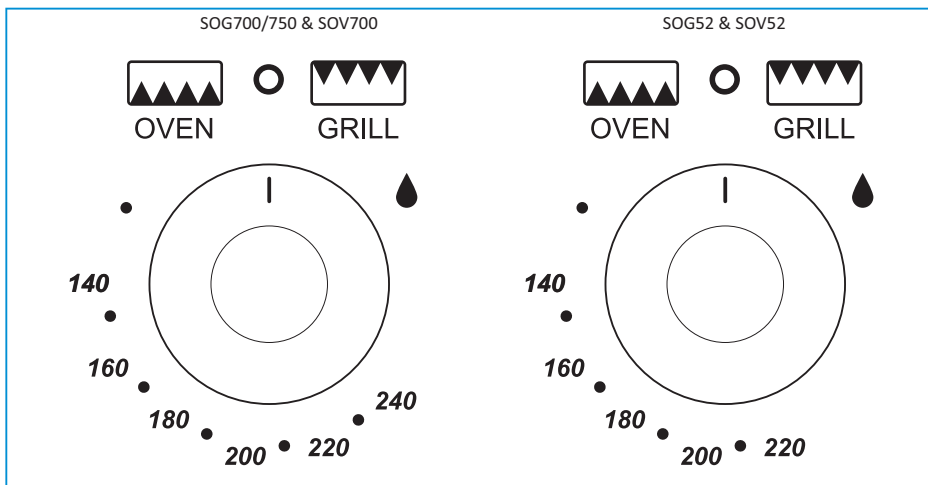

For the exact location of the control knob, see Main components.

Turning on:

- Open the door and push in the control knob.
- Continue pressing the knob and turn it anti-clockwise to the full rate position (240°C, gas mark 7/9).
 - For spark ignition models: Push the ignition button.
 - For non-ignition models: Hold a lit match or gas match to the burner.
- Keep the control knob pressed for about 10-15 seconds and then release it.
- Adjust the required heat setting.
- The grill pan supplied is multi-functional, for use in grill or oven and the handle design allows removal or insertion whilst the pan is in use. Always remove the handle when the pan is in use.
- Place the shelf in the required position.



Ignition must always be carried out with the oven door open.



If the burner accidentally extinguishes turn the control knob to the 0 position and wait at least 1 minute before re-igniting the burner.



If the burner has not lit within 15 seconds turn the control knob back to the 0 position and release it. Wait at least 1 minute and repeat the steps above to turn on the appliance.



Although the oven heats up quickly, a 10 minute preheat is recommended. The oven should reach full temperature in about 15-20 minutes.

Turning off:

- Turn the control knob clockwise to the 0 position to turn off the burner.



Always make sure the control knob is in the 0 position and the oven door is closed when you have finished using the oven.

8. Safe cooking

- The pans and trays supplied with this appliance are the maximum sizes. Do not use larger pans and trays. They may restrict good circulation of heat, which may increase cooking times.
- The oven shelf allows good circulation at the rear of the oven.
- A raised bar at the rear of the shelf prevents trays or dishes making contact with the back of the oven.
- To remove a shelf, pull it forward until it stops, raise at the front and remove.
- To place a shelf in the oven, lower it at the front and slide it backward until it stops.
- The appliance is fitted with a cooling system (only for SOG52 & SOV52). The cooling fan will automatically switch on a few minutes after the grill and/or oven is turned on, and will remain on even after the appliance has been switched off.
- The fan will automatically switch off a few minutes after the appliance has been switched off, when the appliance has cooled sufficiently (only for SOG52 & SOV52).
- When either the grill or oven is first lit or after switching off, the cooling fan may operate intermittently (only for SOG52 & SOV52). This is normal.
- Do not leave the appliance unattended when in use.
- Do not use the appliance while the vehicle is moving.
- Turn the control knob back to the 0 position after cooking.
- Keep the appliance clean and prevent accumulation of grease and food scraps.



Never cover slots or holes in the appliance and never cover a shelf with materials such as aluminium foil. That restricts the airflow and may cause carbon monoxide poisoning.





The food shelves and trays in the appliance are hot during and after use. Allow all parts to cool before touching them, as this can cause serious injury. Always use oven gloves when removing the shelves and trays.



9. Temperature control

The temperature in the oven is controlled by a thermostatic gas tap and is variable over the range 130°C to 240°C for SOG700 / 750 & SOV700 and over the range 130°C to 220°C for SOG52 & SOV52.

The table below provides a guide to the approximate temperatures at each of the shelf positions with respect to the gas mark setting. Good use can be made of the temperature variation between the shelf positions, as several dishes requiring different temperatures may be cooked at the same time. In this way maximum benefit can be obtained from the gas used to heat the oven.

Table 1: Approximate temperature zones

Gas mark				Dish
1/4 - 1/2	90°C	110°C	130°C	Meringues
1	110°C	130°C	150°C	Stewed fruit
2	120°C	140°C	160°C	Rich fruit cake, rice pudding
3	130°C	150°C	170°C	Baked custard, shortbread fingers

Gas mark				Dish
4	140°C	160°C	185°C	Victoria sponge
5	155°C	180°C	200°C	Whisked sponges, ginger nuts
6	170°C	190°C	220°C	Short crust pastry
S0G700 / 750 & S0V700 only:				
7	185°C	210°C	230°C	Bread, scones, flaky pastry
8	200°C	220°C	245°C	Puff pastry
9	215°C	240°C	260°C	Quick browning



Care should be taken not to overload the oven, allow adequate spacing to ensure free circulation of heat.



When roasting with aluminium foil ensure the foil does not impair circulation of heat or block any oven flue outlet.

10. Maintenance and cleaning

Thetford recommends an annual inspection service by an approved service centre. Between annual servicing, clean the appliance regularly after use. Before any cleaning work is started, the appliance should have been left to cool and be disconnected from the gas and/or electrical supplies.

- Always remove any spills or contamination immediately after use with soap and hot water. Towel dry the surface with a soft cloth.
- Use a non-abrasive multi-purpose cream cleaner and a nylon scourer pad to clean more stubborn dirt or grease.
- Use a proprietary stainless steel cleaner or polish to remove superficial surface scratching.



Do not use abrasive cleaners, metal scouring pads or hard brushes. They could damage the appliance.



Do not leave wet cloths, cleaning pads, residues of food or cleaning products or other dirt to dry on the surface. It can cause pitting, marking or even rusting.



Always clean in the direction of the brushed finish and not across the grain.



Cleaning agents containing bleach should not be left in contact with stainless steel.



Mineral content in water (such as iron or lime scale) can affect the appearance of the metal.



The control knob can be removed for cleaning. The knob is easy to replace.

11. Gas leaks

As soon as you smell gas:

- Ensure that all burners are turned off.
- Extinguish all naked lights and do not smoke.
- Shut off the gas supply at the gas bottle immediately.
- Do not use electrical switches.
- Open all doors and windows.









LPG is heavier than air. Escaping gas accumulates at lower levels. By following the strong, unpleasant smell of gas, you can determine where the leak is located. To investigate where it is exactly, use a special leak detection spray. Never use an open flame to find the leak!







12. Putting in storage

- Close the gas valve at the gas bottle.
- Spark ignition models only: Disconnect the battery.
- Ensure that the control knobs are in the 0 position.
- Close the oven door.
- Wipe the appliance clean and dry.

13. Technical specifications

Table 2: Burner specifications

	S0G700 / 750 series			S0V700 series		
	Gas input		Injector	Gas input		Injector
						
	kW	g/hr	mm	kW	g/hr	mm
Oven burner	1.6	115	0.59	1.6	115	0.59
Grill burner	1.5	108	0.62			
Total	1.6	115		1.6	115	

	S0G52 series			S0V52 series		
	Gas input		Injector	Gas input		Injector
						
kW	g/hr	mm	kW	g/hr	mm	
Oven burner	1.1	72	0.50	1.1	72	0.50
Grill burner	1.6	108	0.64			
Total	1.6	108		1.1	72	



This appliance is suitable for use with LPG (Liquefied Petroleum Gas).



Use only the type of gas and the pressures specified.



This appliance must be earthed.

14. Disposal

Your product has been designed and manufactured with high quality materials and components, which can be recycled and reused. When your product has reached its end of life, dispose of the product according to the local rules. Do not dispose of the product with the normal household waste. The correct disposal of your old product will help prevent potential negative consequences to the environment and human health.

15. Service & questions

Service

Before any service work is started, the appliance should have been left to cool and be disconnected from both the gas and electrical supplies. After each service the appliance must be checked for gas soundness and electrical safety.



All servicing must be carried out by an approved competent person.

Troubleshooting

Problem	Possible cause	Solution
Burner does not burn or burns unevenly	Gas bottle is empty Gas tap is closed Burner is wet or clogged	Change gas bottle Open tap Dry or clean burner

Problem	Possible cause	Solution
Spark ignition does not spark	12V DC battery is discharged Connections are loose Ignition points are wet or dirty	Charge battery Secure connections Dry or clean ignition points
Control knob does not function	Knob is mounted incorrectly	Install knob correctly

For more troubleshooting look on the website www.thetford.com

Questions

If you have questions about your product, parts, accessories or authorised services visit www.thetford.com.

If you contact an authorised local Service Centre in your country, provide the details of the model and serial number plus the date of purchase.



Warranty

For our warranty clause, please refer to the conditions mentioned on www.thetford.com.

Declaration of Conformity

Thetford hereby declares that this product is in compliance with the essential requirements and other relevant provisions of the applicable Directives and Standards. A copy of the Declaration of Conformity can be found at www.thetford.com

EUROPEAN HEADQUARTERS

Thetford B.V.
P.O. Box 169
4870 AD Etten-Leur
The Netherlands

T +31 76 504 22 00
F +31 76 504 23 00
E info@thetford.eu

FRANCE

Thetford S.A.R.L.
Parc BUIROPLUS / Bâtiment 6
18, Boulevard de la Paix
CS 80008
95895 Cergy Pontoise Cedex
France

T +33 1 30 37 58 23
F not available
E infof@thetford.eu

SCANDINAVIA

Thetford Scandinavia
Bangatan 6
521 43 Falköping
Sverige

T +46 31 336 35 80
F not available
E infos@thetford.eu

UNITED KINGDOM

Thetford Ltd.
Unit 6
Brookfields Way
Manvers, Rotherham
S63 5DL, England
United Kingdom

T +44 844 997 1960
F +44 844 997 1961
E infofgb@thetford.eu

ITALY

Thetford Italy c/o Tecma s.r.l.
Via Flaminia
Loc. Castel delle Formiche
05030 Otricoli (TR)
Italia

T +39 0744 709071
F +39 0744 719833
E infoi@thetford.eu

AUSTRALIA

Thetford Australia Pty. Ltd.
130-132 Freight Drive
Somerton VIC 3062
Australia

T +61 3 9358 0700
F not available
E infoaus@thetford.com.au
www.thetford.com.au

GERMANY

Thetford GmbH
Schallbruch 14
D-42781 Haan
Deutschland

T +49 2129 94250
F +49 2129 942525
E infofod@thetford.eu

SPAIN AND PORTUGAL

Mercè Grau Solà
Agente para España y Portugal
c/ Castellet, 36 bxs 2a
08800 Vilanova I la Geltrú
Barcelona
España

T +34 938 154 389
F not available
E infofsp@thetford.eu

CHINA

Thetford China
Rm. 1207, Coastal Building
(East Block)
Haide 3rd Road, Nanshan District
Shenzen, 518054
China

T +86 755 8627 1393
F +86 755 8627 1673
E info@thetford.cn
www.thetford.cn