

THE  **FORD**



Hob 900 Series

User Manual



DECLARATION OF CONFORMITY

We: THETFORD Ltd

Address: Unit 6 Brookfields Way, Manvers, Rotherham, S63 5DL
Telephone: (+44) (0) 844 997 1960. Fax: (+44) (0) 844 997 1961

Declare under our sole responsibility that;

Product Types; Domestic build-in LP Gas cooking appliances;

Model Number/Description; Topline SHB165xx, SHB167xx, SHB168xx & SHB169xx Series Recessed Glass Hobs; SHB265xx, SHB267xx & SHB269xx Series Recessed Glass Hobs; SCU111xx Series Recessed Combination Glass Hobs; SHB91xxx, SHB92xxx, SHB93xxx, SHB94xxx & SHB96xxx Series Surface-Mounted Glass Hobs; SCU10xxx Series Surface-Mounted Combination Glass Hobs;

Are in conformity with the relevant European Union harmonization legislation, Regulation (EU) 2016/426, which applies as from 21 April 2018 and are manufactured in accordance with the harmonised European standards; EN 30-1-1:2008+A3:2013 & EN 30-2-1:2015;

Satisfy the essential requirements of the Electro Magnetic Compatibility Directive 2014/30/EU and are manufactured in accordance with the harmonized European standards; EN 55014-1: 2006 + A1:2009 + A2:2011 & EN55014-2: 1997 + A1:2001 + A2: 2008;

We also declare that the production of each specific model will be in conformity with the type as described in the EC type-examination certificate;

CE 680547, Issued by BSI

We also declare that the production of each specific model will be in conformity with the type as described in Test Report(s):

8712931, 8374793, 8427154 & TR 15/048, Issued by BSI

Name : Bartho Anderson
Title/Position : Director
Place & Date of Issue : Rotherham 23rd February 2018

Signature : [Handwritten Signature]

EN

Original User Manual

Contents

| | | |
|----|-------------------------------|----|
| 1 | Introduction..... | 2 |
| 2 | Symbols..... | 2 |
| 3 | Safety..... | 3 |
| 4 | Main components..... | 5 |
| 5 | Before use..... | 7 |
| 6 | Use of the burners..... | 8 |
| 7 | Safe cooking..... | 8 |
| 8 | Maintenance and cleaning..... | 11 |
| 9 | Gas leaks..... | 11 |
| 10 | Troubleshooting..... | 11 |
| 11 | Servicing..... | 12 |
| 12 | Putting in storage..... | 12 |
| 13 | Technical specifications..... | 13 |
| 14 | Disposal..... | 14 |
| 15 | Questions..... | 14 |
| 16 | Warranty..... | 14 |

1. Introduction

This is the user manual for your Thetford hob. Read the safety instructions and information on use and maintenance of the hob carefully before continuing. This will enable you to use the hob safely and efficiently. Retain this manual for future reference.

For the latest version of this manual, please visit www.thetford-europe.com.

2. Symbols

Key to symbols:



Warning. Risk of injury and/or damage.



Caution. Hot surface. Risk of injury and/or damage.



Attention. Important information.



Note. Information.

3. Safety

EN



This appliance may be used by children aged 8 years or older and persons with reduced physical, sensory or mental capabilities and/or lack of experience and knowledge only if they are supervised or have been given instructions on the safe use of this appliance and understand the potential hazards.



Keep children younger than 8 years away from the appliance, except under constant supervision.



Do not allow children to play with the appliance.



Do not allow children to clean or maintain this equipment unattended.



Use only parts supplied by the manufacturer.



Do not change or adjust anything on the appliance, unless the change is authorised by the manufacturer or its representative.



Use the appliance for cooking only and not for anything else, for example room heating. This can lead to carbon monoxide poisoning and overheating. The manufacturer cannot be held liable for damage resulting from improper use or incorrect setting of the controls.



This appliance is not intended to be operated by means of an external timer or separate remote-control system.

The use of this gas cooking appliance results in the production of heat, moisture and products of combustion in the room in which it is installed.



Ensure the room has sufficient ventilation when the appliance is in use. During prolonged use, additional ventilation may be needed by opening a window or increasing the extraction force of the hood.



Never extinguish a cooking fire with water. Turn the burner off and cover the flame with a lid or a fire blanket.



The burners and pan supports are hot during and after use. Allow all parts to cool before touching them, as this can cause serious injury.



Unattended cooking on a hob with fat or oil can be dangerous and may result in fire. Do not leave the appliance unattended when in use.



The use of inappropriate hob guards can cause accidents.



Do not store items on the cooking surface of the hob.



Do not use steam cleaners or pressure washers to clean the appliance. See Maintenance and cleaning for instructions.



Do not allow oil or fat to build up on the appliance. Clean the appliance after each use.

4. Main components

SHB910

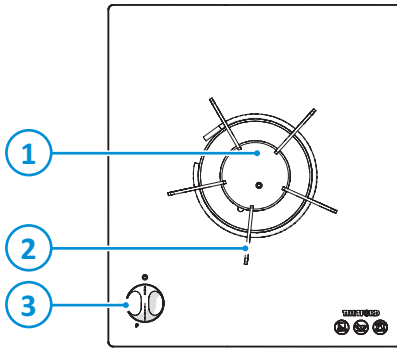

1. Gas burner
2. Pan support
3. Control panel

EN

SHB922

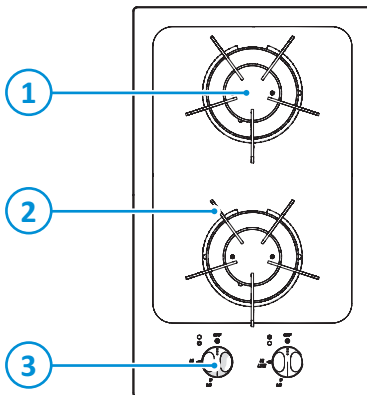

1. Gas burners
2. Pan supports
3. Control panel

SHB923

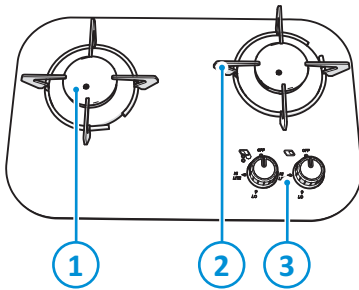

1. Gas burners
2. Pan supports
3. Control panel

SHB931

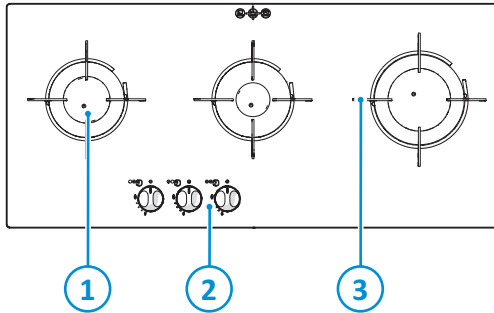

1. Gas burners
2. Control panel
3. Pan supports

SHB932

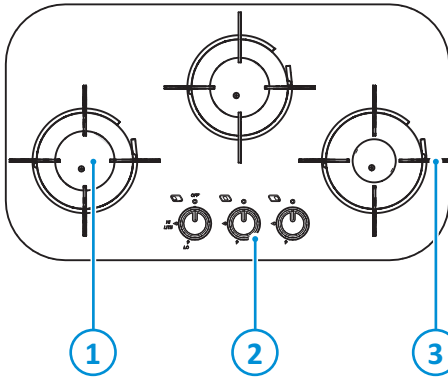

1. Gas burners
2. Control panel
3. Pan supports

EN

SHB969

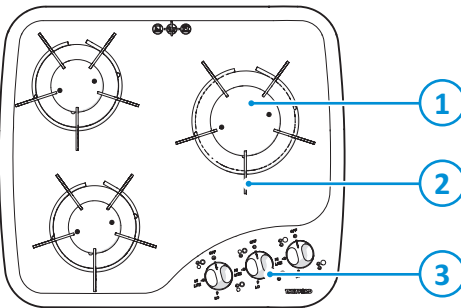

1. Gas burners
2. Pan supports
3. Control panel

The types of burners may vary depending on the type of appliance. Refer to Technical specifications for further details.

5. Before use

Before using the appliance:

- Ensure that all packaging materials have been removed.
- Clean the appliance with warm water and household detergent and dry carefully with a soft cloth.
- Ensure that the gas supply is connected and turned on.
- Ensure that the appliance is connected to the 12V DC battery for the spark ignition.
- Ensure that the pan supports are positioned properly.
- Ignite the gas burners and let them burn to expel odours and vapours first.



Only use LPG (Liquefied Petroleum Gas). The appliance operates on propane or butane. Propane is preferred over butane, because butane provides poor performance at an ambient temperature below 10°C and cannot be used at an ambient temperature below 5°C.

6. Use of the burners

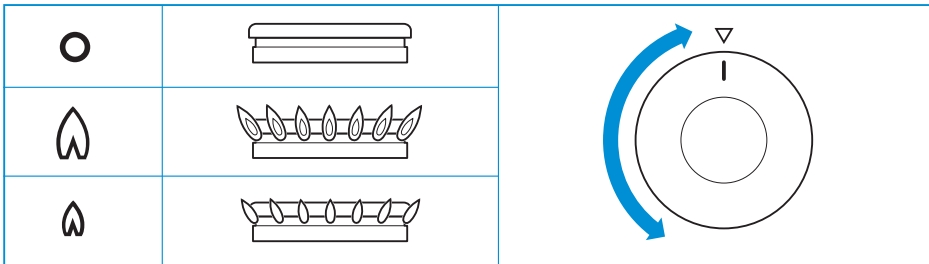

For the exact location of the control knobs, see Main components.

Turning on:

- Push and turn the control knob.
- Turn the control knob anti-clockwise to the full rate position.
 - For automatic ignition models: The automatic ignition sparks and lights.
 - For non-ignition models: Hold a lit match or gas match to the burners.
- Keep the control knob pressed for about 10-15 seconds and then release it.
- Adjust the height of the flame.



If the burner accidentally extinguishes turn the control knob to the 0 position and wait at least 1 minute before re-igniting the burner.



If the burner has not lit within 15 seconds turn the control knob back to the 0 position and release it. Wait at least 1 minute and repeat the steps above to turn on the appliance.

Turning off:

- Turn the control knob clockwise to the 0 position to turn off the burner.



Always make sure the control knob is in the 0 position when you have finished using the gas burners.

7. Safe cooking

- Do not allow cooking vessels to overlap the edges of the appliance – use the correct sizes of pans and position them centrally over the burners.

SHB910

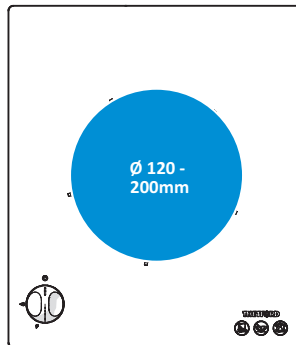

EN

SHB922

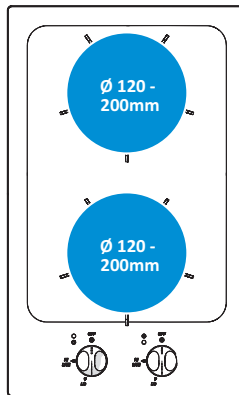

SHB923

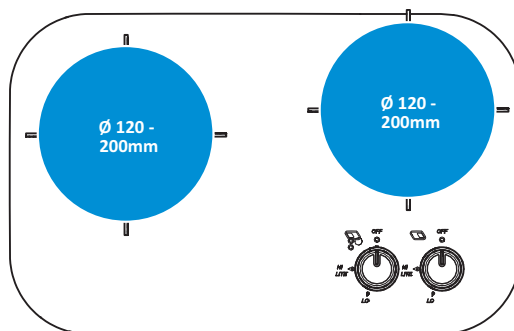

SHB931

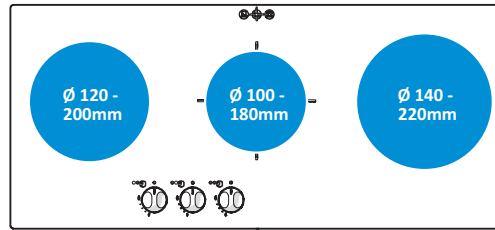

SHB932

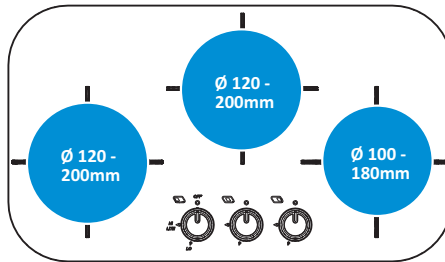

SHB969

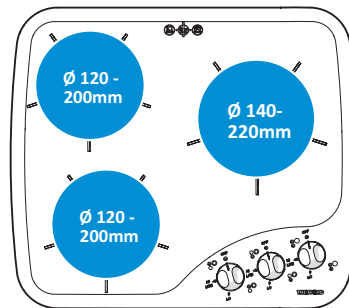

- Ensure that there is at least a 10mm gap between the pans and the edges of the hob.
- Turn the pans so that the handles do not overhang the front of the appliance.
- Ensure that the flame of the gas burner heats the bottom of the pan, not the sides.
- Do not leave the appliance unattended when in use.
- Do not use the appliance while the vehicle is moving.
- Turn the control knob back to the 0 position after cooking.
- Keep the appliance clean and prevent accumulation of grease and food scraps.

8. Maintenance and cleaning

Thetford recommends an annual inspection service by an approved service centre. Between annual servicing, clean the appliance regularly after use. Before any cleaning work is started, the appliance should have been left to cool and be disconnected from the gas and electrical supplies.

- Always remove any spills or contamination immediately after use with soap and hot water. Towel dry the surface with a soft cloth.
- Use a non-abrasive multi-purpose cream cleaner and a nylon scourer pad to clean more stubborn dirt or grease.
- For routine cleaning of the glass surface, use a cleaning cream and clean cloth or paper towel. After cleaning, wipe dry with a dry paper towel.



Do not use abrasive cleaners, metal scouring pads or hard brushes. They could damage the appliance.



If you clean the burner rings, ensure that the holes are not clogged.



The control knobs can be removed for cleaning. The knobs are easy to replace.

EN

9. Gas leaks

As soon as you smell gas:

- Ensure that all burners are turned off.
- Extinguish all naked lights and do not smoke.
- Shut off the gas supply at the gas bottle immediately.
- Do not use electrical switches.
- Open all doors and windows.



LPG is heavier than air. Escaping gas accumulates at lower levels. By following the strong, unpleasant smell of gas, you can determine where the leak is located. To investigate where it is exactly, use a special leak detection spray. Never use an open flame to find the leak!

10. Troubleshooting

| Problem | Possible cause | Solution |
|--------------------------------------|--|--|
| Burners do not burn or burn unevenly | Gas bottle is empty Gas tap is closed Burner caps are not correctly positioned Burners are wet or clogged | Change gas bottle Open tap Allow caps to cool, then re-position them Dry or clean burners |
| Automatic ignition does not spark | 12V DC battery is discharged Connections are loose Ignition points are wet or dirty | Charge battery Secure connections Dry or clean ignition points |

| Problem | Possible cause | Solution |
|-------------------------------|-------------------------------|-------------------------|
| Control knobs do not function | Knobs are mounted incorrectly | Install knobs correctly |



If you cannot solve a problem, contact the authorised local Service Centre or Thetford Customer Service in your country.

11. Servicing

All servicing must be carried out by an approved competent person. Before any service work is started, the appliance should have been left to cool and be disconnected from both the gas and electrical supplies. After each service the appliance must be checked for gas soundness and electrical safety.

For service, please contact your authorised local Service Centre giving details of the model and serial number on the data badge plus date of purchase.









| Model Name & Series Number | |  | |
|----------------------------|--|---|-----------------------|
| G30 G31 | CAT I ₃ +(28-30/37) BUTANE 28-30mbar PROPANE 37mbar | CAT I ₃ B/P(30) BUTANE 30mbar PROPANE 30mbar | THETFORD |
| ΣQn | Power kW (g/hr) | Model Number | Spark Ignition |
| CE | Pin Number | Serial Number | Voltage ~ 50 Hz |
| Country Codes 1 | | Country Codes 2 | Power kW |
| | | | QC Pass Order No |

12. Putting in storage







- Close the gas valve at the gas bottle.
- Disconnect the battery.
- Ensure that the control knobs are in the 0 position.
- Wipe the appliance clean and dry.







13. Technical specifications

Table 1: Burner specifications

| | SHB910 series - option 1 | | | SHB910 series - option 2 | | | SHB922 series | | |
|-------------|---|---|---|---|---|---|---|---|---|
| | Gas input | | Inject- or | Gas input | | Inject- or | Gas input | | Inject- or |
| |  |  |  |  |  |  |  |  |  |
| | kW | g/hr | mm | kW | g/hr | mm | kW | kW | mm |
| Gas burners | 1.5 | 108 | 0.61 | 2.4 | 173 | 0.77 | 2 x 1.5 | 2 x 108 | 0.61 |
| Total | 1.5 | 108 | | 2.4 | 173 | | 3.0 | 216 | |

EN

| | SHB923 series | | | SHB931 series | | |
|-------------|---|---|---|---|---|---|
| | Gas input | | Injector | Gas input | | Injector |
| |  |  |  |  |  |  |
| | kW | g/hr | mm | kW | g/hr | mm |
| Gas burners | 2 x 1.5 | 2 x 108 | 0.61 | 1 x 2.4 1 x 1.5 1 x 1.0 | 1 x 173 1 x 108 1 x 72 | 0.77 0.61 0.52 |
| Total | 3.0 | 216 | | 4.9 | 353 | |

| | SHB932 series | | | SHB969 series | | |
|-------------|---|---|---|---|---|---|
| | Gas input | | Injector | Gas input | | Injector |
| |  |  |  |  |  |  |
| | kW | g/hr | mm | kW | g/hr | mm |
| Gas burners | 2 x 1.5 1 x 1.0 | 2 x 108 1 x 72 | 0.61 0.52 | 1 x 2.4 2 x 1.5 | 1 x 173 2 x 108 | 0.77 0.61 |
| Total | 4.0 | 288 | | 5.4 | 389 | |



This appliance is suitable for use with LPG (Liquefied Petroleum Gas) and should not be used with any other gas.



This appliance must be earthed.

14. Disposal

Your product has been designed and manufactured with high quality materials and components, which can be recycled and reused. When your product has reached its end of life, dispose of the product according to the local rules. Do not dispose of the product with the normal household waste. The correct disposal of your old product will help prevent potential negative consequences to the environment and human health.

15. Questions

If you have questions about your product, parts, accessories or authorised services:

- Visit www.thetford-europe.com.
- If you cannot solve a problem, contact the authorised local Service Centre or Thetford Customer Service in your country.

16. Warranty

For our warranty clause, please refer to the conditions mentioned on www.thetford-europe.com/service/warranty. For more information, please contact the Thetford Customer Service in your country.

EUROPEAN HEADQUARTERS

Thetford B.V.
Nijverheidsweg 29
P.O. Box 169
4870 AD Etten-Leur
The Netherlands

T +31 76 504 22 00
F +31 76 504 23 00
E info@thetford.eu

UNITED KINGDOM

Thetford Ltd.
Unit 6
Brookfields Way
Manvers, Rotherham
S63 5DL, England
United Kingdom

T +44 844 997 1960
F +44 844 997 1961
E info@thetford.eu

GERMANY

Thetford GmbH
Schallbruch 14
D-42781 Haan
Deutschland

T +49 2129 94250
F +49 2129 942525
E info@thetford.eu

FRANCE

Thetford S.A.R.L.
Parc BUROPLUS / Bâtiment 6
18, Boulevard de la Paix
95800 CERGY
France

T +33 1 30 37 58 23
F +33 1 30 37 97 67
E info@thetford.eu

ITALY

Thetford Italy c/o Tecma s.r.l.
Via Flaminia
Loc. Castel delle Formiche
05030 Otricoli (TR)
Italia

T +39 0744 709071
F +39 0744 719833
E info@thetford.eu

SPAIN AND PORTUGAL

Mercè Grau Solà
Agente para España y Portugal
c/ Castellet, 36 bxs 2ª
08800 Vilanova i la Geltrú
Barcelona
España

T +34 938 154 389
F not available
E info@thetford.eu

SCANDINAVIA

Thetford B.V.
Representative Office Scandinavia
Hantverkaregatan 32D
521 61 Stenstorp
Sverige

T +46 31 336 35 80
F +46 31 44 85 70
E info@thetford.eu

AUSTRALIA

Thetford Australia Pty. Ltd.
41 Lara Way
Campbellfield VIC 3061
Australia

T +61 3 9358 0700
F +61 3 9357 7060
E info@thetford.eu
www.thetford.com.au

CHINA

Thetford China
Rm. 1207, Coastal Building
[East Block]
Haide 3rd Road, Nanshan District
Shenzhen, 518054
China

T +86 755 8627 1393
F +86 755 8627 1673
E info@thetford.cn
www.thetford.cn